



**HANDLING AND
TRANSPORT SOLUTIONS
FOR THE PHARMACEUTICAL INDUSTRY**

PHARMACEUTICAL INDUSTRY

HEALTH, SAFETY AND PRODUCTIVITY

The production process in the pharmaceutical sector involves high standards of hygiene, safety and productivity to ensure a safe, compliant and effective end product.

ENSURING SECURITY
OF OPERATORS



PRODUCTION EFFICIENCY



AVOID CONTAMINATION



ENSURE CONTAINMENT OF ACTIVE
SUBSTANCES AND INGREDIENTS



ENSURE THE QUALITY OF THE
FINISHED PRODUCT



MAINTAIN HIGHEST LEVEL OF HYGIENE IN
THE WORK ENVIRONMENT



Based on these priorities, Delfin offers an innovative range of pharmaceutical-specific solutions that includes dust containment systems with varying degree of dangerousness (API and HPAPI) and different levels of operator exposure risk (OEB1 to OEB5).

THE ADVANTAGES OF THE DELFIN PNEUMATIC CONVEYORS HANDLING SYSTEMS

Thanks to the more than thirty years of experience and continuous investments in research and development, Delfin is able to offer expertise and innovation to the pharmaceutical industry:

The filter and dust containment solutions rank among the most compact, high performance and competitive ones on the market.

Possibility of an electrical interface customised with the production machine.

Continuous handling, conveying and unloading solutions to avoid downtime and to increase productivity.

Certifications on request: GMP, ATEX, HEPA/ULPA compliance.

A comprehensive and diverse range that meets the most specific requirements and standards in the industry.

H14/HEPA absolute filters tested individually that ensure complete integrity of the filter and of its characteristics as well as total quality control of the filter itself.

Full range of material handling solutions in production systems (including clean rooms)

Modular positioning solutions in rooms outside the production area to optimise spaces and to avoid noise and thermal emissions.

A COMPLETE RANGE OF SOLUTIONS

Delfin Pneumatic Conveyors offers the pharmaceutical industry a wide choice of pneumatic conveying solutions that integrate perfectly into the production process, from the first stage of storage of raw materials to the process of packaging the finished product.

1 SOLUTIONS FOR THE LOGISTICS AND STORAGE AREAS OF RAW MATERIALS

2 SOLUTIONS FOR PRE-PRODUCTION AREAS

3 SOLUTIONS FOR PRODUCTION AREAS

4 SOLUTIONS FOR CLEAN ROOMS

5 SOLUTIONS FOR PACKAGING LINES

DOSAGE

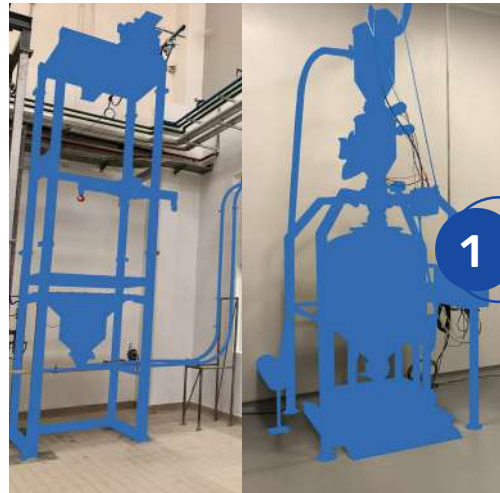

Solutions for sampling and dosing quantities of raw material/excipient, weighing what is dispensed through the use of dedicated equipment (loading cells and dosing valves) and automated sending to production.

LOADING AND CONVEYING OF RAW MATERIALS OR FINISHED PRODUCTS

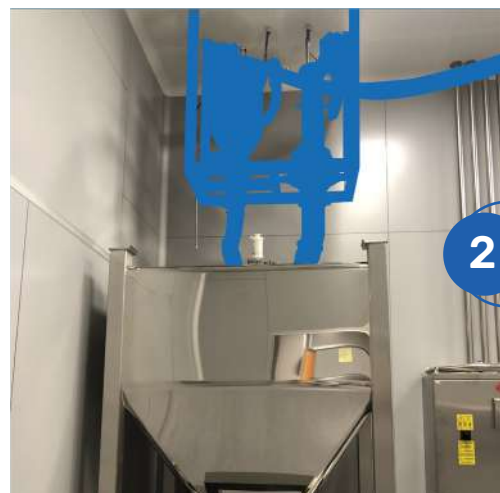

Integrated solutions for the automation of the loading of raw materials or for the conveying of finished products.

1 SOLUTIONS FOR THE LOGISTICS AND STORAGE AREAS OF RAW MATERIALS

2 SOLUTIONS FOR PRE-PRODUCTION AREAS

3 SOLUTIONS FOR PRODUCTION AREAS

4 SOLUTIONS FOR CLEAN ROOMS

5 SOLUTIONS FOR PACKAGING LINES

INTEGRATED SOLUTIONS FOR SAFE CONTAINMENT

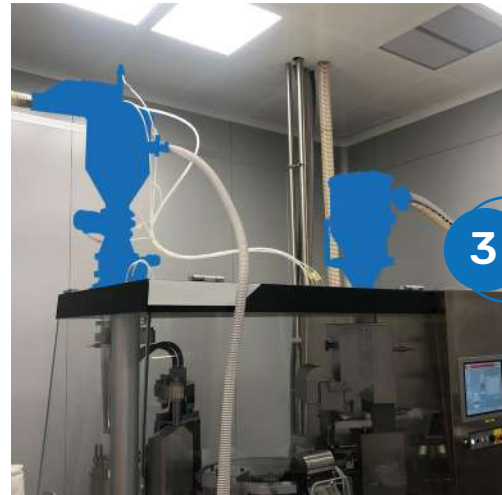

Ideal solution for the loading of powders into process machinery. The powder, tablets or capsules can be loaded directly and hermetically into the machine, avoiding any risk of contamination with the external environment.

CLEANROOM



Excellent solution for the conveying and airtight loading of materials inside the clean room. It guarantees non-alteration of the moved product, in compliance with the high standards of the pharmaceutical industry.

PACKAGING LINE SOLUTION

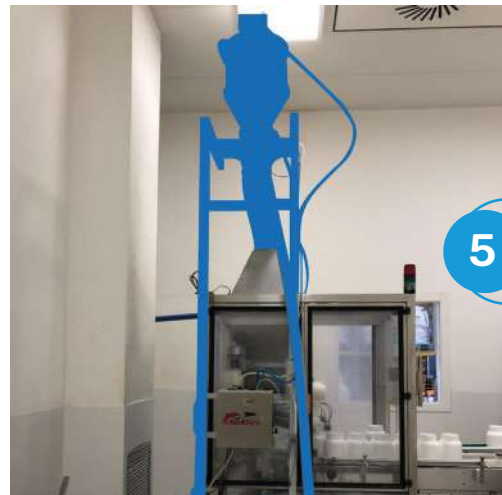

Integrated solutions in packaging lines with an automated process, reducing waste and processing times.



FULL INTEGRATION FOR MAXIMUM PRODUCTION EFFICIENCY

Delfin research and development department is working to develop vacuum systems seamlessly integrated on production machinery, with complete automation of vacuum operations and improvement of production efficiency.

Technology and modular solutions offered by Delfin can be designed and customised according to the specific needs and features of each client.

BENEFITS:

- INCREASED SAFETY FOR OPERATORS
- HIGH QUALITY OF FINISHED PRODUCTS
- IMPROVED LEVELS OF PRODUCTION EFFICIENCY AND COST REDUCTION
- REGULATORY COMPLIANCE

INDUSTRY 4.0

Delfin solutions can be customised to effectively communicate with the company SCADA or ERP system, enabling advanced interaction with machinery in the production process.

Thanks to integrated and digital 4.0 systems it is possible to perform preventive and predictive maintenance of the production system on which the vacuum system has been integrated.

BENEFITS:

- IMMEDIATE DETECTION OF FAULTS
- REDUCTION OF MACHINE DOWNTIME
- REDUCTION OF TECHNICAL REPAIR COSTS
- PREVENTION OF FAULTS CAUSED BY INCORRECT USE
- INCREASED SECURITY
- REMOTE SUPPORT OPTIONS FOR OPERATORS
- MAINTENANCE SCHEDULING
- MAXIMISED PERFORMANCES

COMMON APPLICATIONS

BLENDER -
MIXER



REACTOR OR TANKS



FLUID BED TO BIN



GRANULATOR

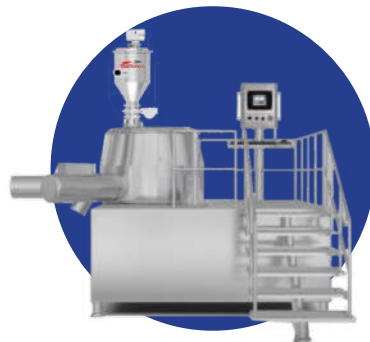

BIG BAG
EMPTYING STATION

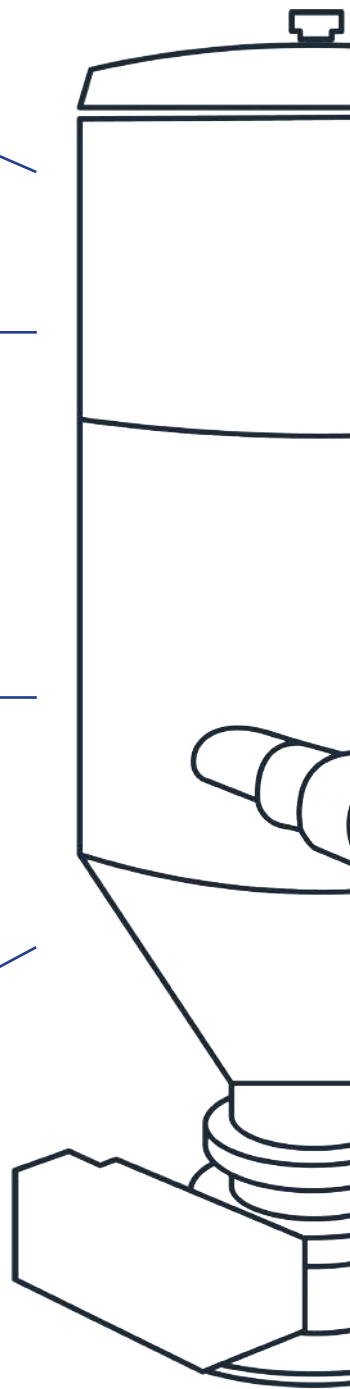
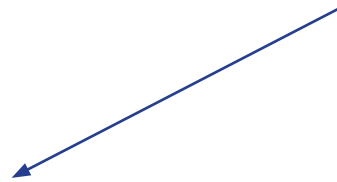
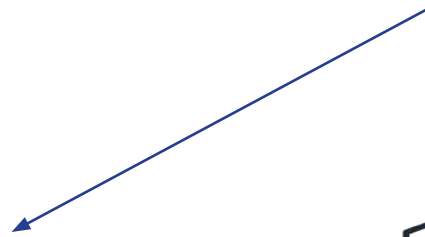
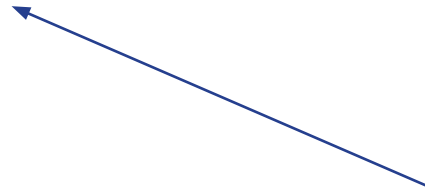
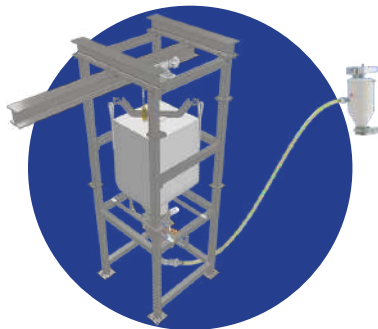

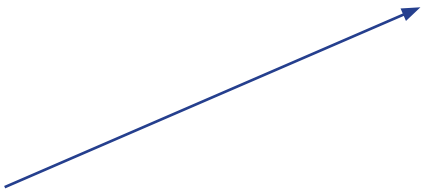
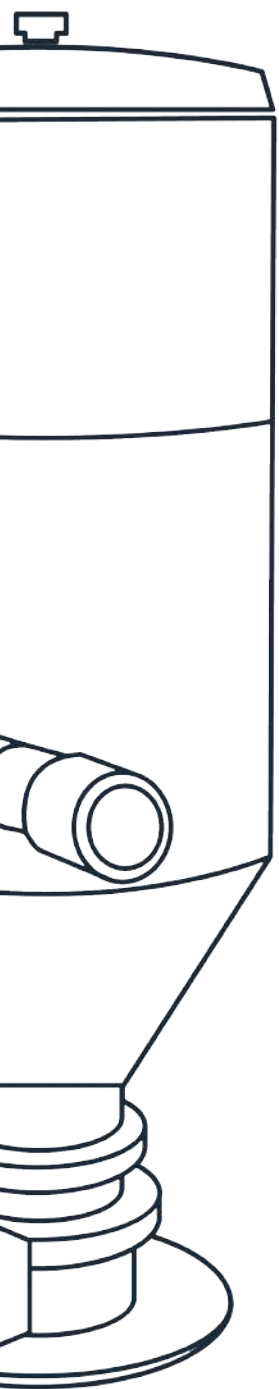

SIEVING MACHINE



TABLET COATER

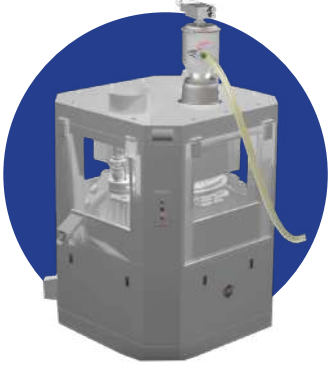

TABLET MACHINE

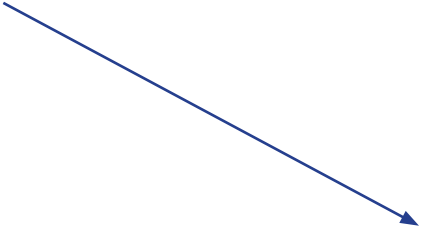

BATCHING STATION

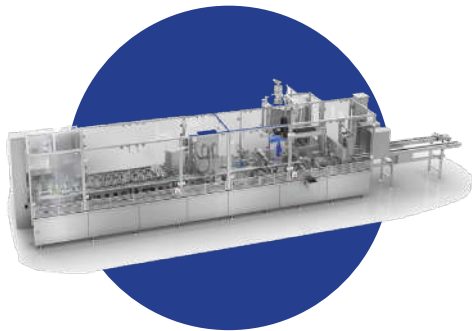
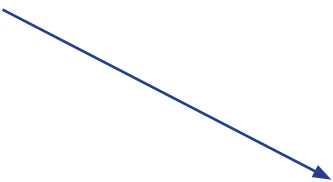

BLISTER MACHINE

PNEUMATIC CONVEYOR FOR DUST COLLECTION AND LOADING INSIDE PROCESS MACHINERY

TECH.280P AND TECH.280PS

The easy installation of the system allows improving of the production efficiency, replacing manual operation with fully automated and safe management.

BENEFITS:

- No contamination or de-mixing of the powders being conveyed
- A high level of hygiene and safety within the production department
- High flexibility of use and easy interface with industry process machines
- Easy sanitisation and guarantee in compliance with the regulations in force in the pharmaceutical industry

COMPRESSED AIR SUCTION UNIT WITH
MULTI-NOZZLE VENT PUMP

CLAMP CONNECTION
AISI316 STAINLESS STEEL

TANGENTIAL INPUT FOR
PRODUCT LOADING

FOOD GRADE POLYESTER FILTER UNIT
WITH PTFE COATING IN STAINLESS
STEEL AISI316, 1 µm

STRUCTURE IN AISI304 STAINLESS STEEL EXTERNALLY
SATIN-FINISHED AND INTERNALLY POLISHED

UNLOADING UNIT
WITH BUTTERFLY VALVE



OPTIONAL



PHARMACEUTICAL FINISH
Externally polished structure



PNEUMATIC VIBRATOR
With conveyor turbine



ELECTRICAL
POWER SUPPLY

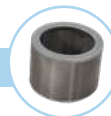

CARTRIDGE FILTER
In AISI 316 stainless
steel, 10µm or 200µm



ACCESSORIES
Product intake loading hopper/
product intake hose



ATEX
Atex certification for
Zone 21 and 22

TECHNICAL DATA	TECH.280P 4V	TECH280PS
Compressed air supply	6 bar	6 bar
Max. depression (5-6-7 bar)	620 - 750 - 780 mBar	620 - 750 - 780 mBar
Max air flow rate	85 - 110 - 130 m³/h	85 - 110 - 130 m³/h
Loading volume	8 lt	3.5 lt
Product unloading	100mm	150mm
Filter	Pleated cartridge	Bag
Size	Ø280 - 77h cm	Ø280 - 45h cm
Weight	18kg	19kg

PNEUMATIC CONVEYOR FOR PICKING AND LOADING FOR LARGE CAPACITIES

TECH420P

The easy installation of the system allows improving of the production efficiency, replacing manual operation with fully automated and safe management.

BENEFITS:

- No contamination or de-mixing of the powders being conveyed
- A high level of hygiene and safety within the production department
- High flexibility of use and easy interface with industry process machines
- Easy sanitisation and guarantee in compliance with the regulations in force in the pharmaceutical industry

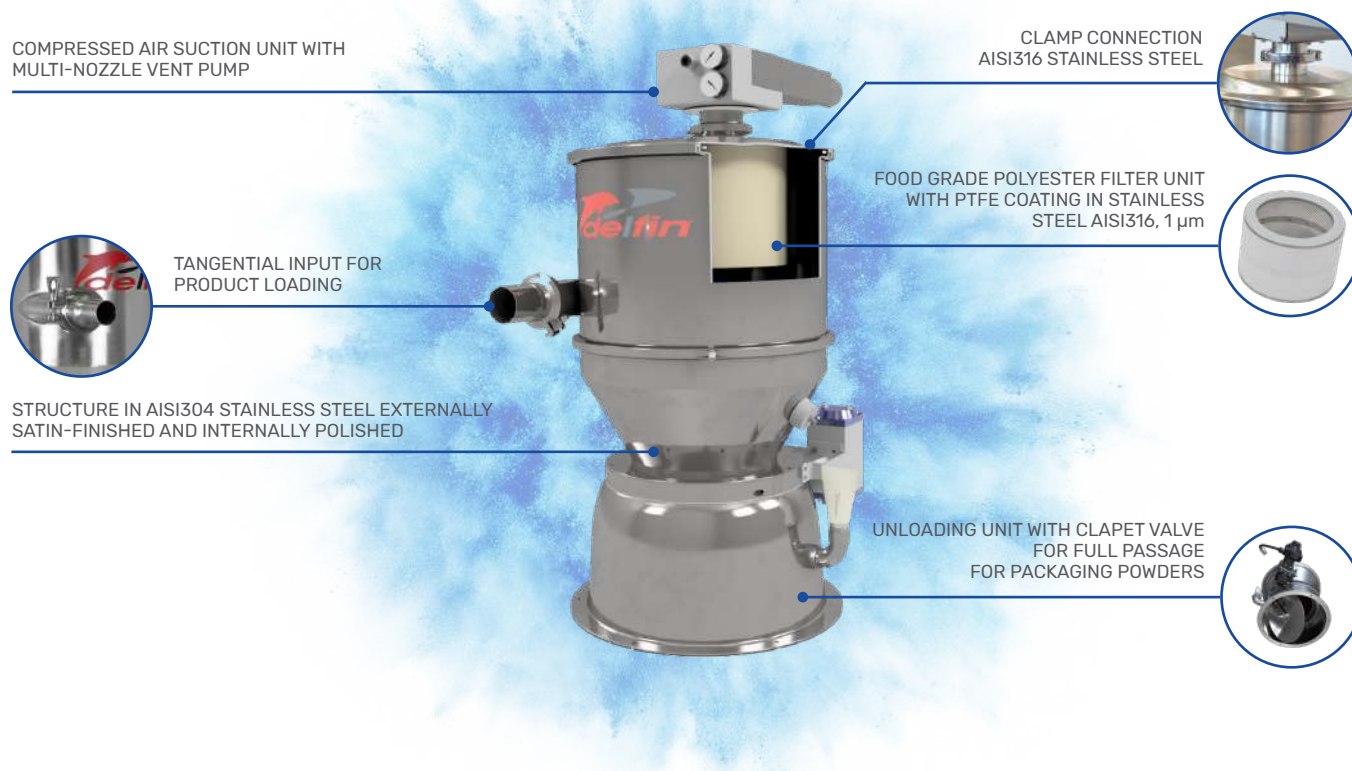

OPTIONAL



PHARMACEUTICAL FINISH
Externally polished structure



PNEUMATIC VIBRATOR
With conveyor turbine



ELECTRICAL POWER SUPPLY

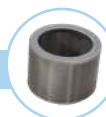

CARTRIDGE FILTER
In AISI 316 stainless steel, 10µm or 200µm



ACCESSORIES
Product intake loading hopper/
product intake hose



ATEX
Atex certification for
Zone 21 and 22

TECHNICAL DATA	TECH.420P 4V	TECH.420P 8V	TECH.420P 15V
Compressed air supply	6 bar	6 bar	6 bar
Max. depression (5-6-7 bar)	620 - 750 - 780 mBar	620 - 750 - 780 mBar	620 - 750 - 780 mBar
Max air flow rate	85 - 110 - 130 m³/h	170 - 200 - 220 m³/h	325 - 380 - 400 m³/h
Loading volume	20 lt	20 lt	20 lt
Product unloading	150 - 250mm	150 - 250mm	150 - 250mm
Filter	Pleated cartridge	Pleated cartridge	Pleated cartridge
Size	Ø420 - h 870 mm	Ø420 - h 870 mm	Ø420 - h 870 mm
Weight	26kg	26kg	28kg

PNEUMATIC CONVEYOR FOR THE HANDLING OF EMPTY CAPSULES WITH MOBILE UNLOADING

CAP-FLOW.280P

Machine consisting of product intake hopper Ø560 and conveyor Ø280 for unaltered product quality and integrity.

BENEFITS:

- Easy sanitisation and guarantee in compliance with the regulations in force in the pharmaceutical industry.
- Precision and quality of the final product.
- Compact size and easy handling.
- High flexibility of use and easy interface with the capsule filling machines or capsuling machines.

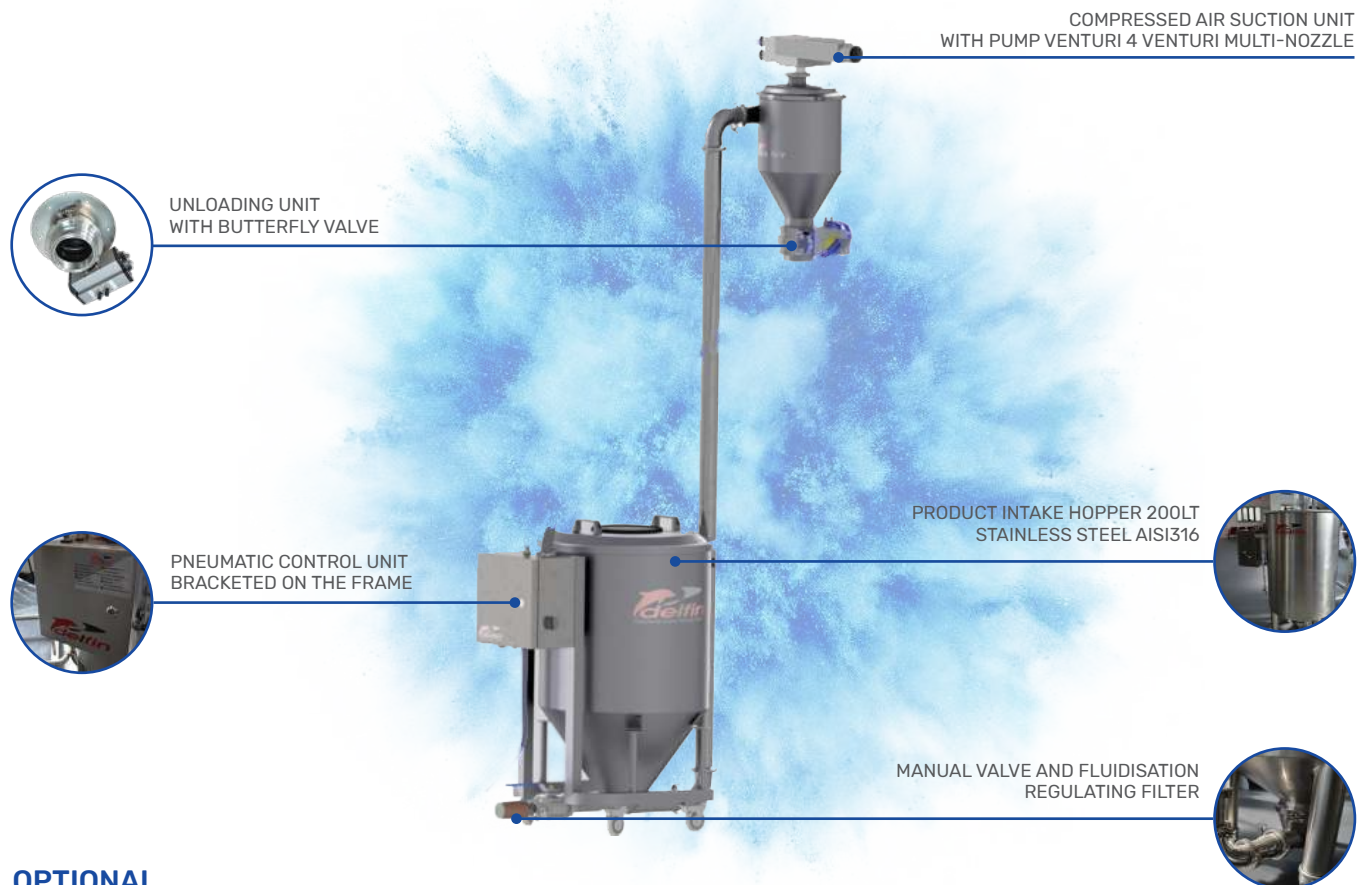

OPTIONAL



ATEX
Atex certification for
Zone 22

TECHNICAL DATA	CAP-FLOW.280P
Compressed air supply	from 3 to 6 bar
Max. depression (5-6-7 bar)	620 - 750 - 780 mBar
Max air flow rate	85 - 110 - 130 m ³ /h
Loading volume	Conveyor 8 lt / Lower hopper 200 lt
Product unloading	100mm
Size	Conveyor -Ø280 - h 770 Lower hopper -Ø560 - h 1100
Weight	Conveyor - 19kg /Lower Hopper - 55kg

MODULAR SOLUTIONS

The modular solutions allow the suction unit to be positioned outside the production area. The pre-separators, due to their compact dimensions, allow reducing of the overall space. Thanks to the absence of dust accumulation points, they guarantee cleanliness, efficiency and easy maintenance.

These models can be supplied with a separate suction unit.



SUCTION UNITS CV RANGE

BENEFITS:

- Thanks to the positioning in the technical compartment, the spaces are optimised and there is no heat release or noise emissions in the production room
- Does not require routine maintenance

4.0

INTERCONNECTION WITH FACTORY
ERP AND PARAMETER CONTROL

INVERTER

FREQUENCY AND SUCTION PARAMETERS
ADJUSTMENT



Option: Atex Certification

TECHNICAL DATA	CV115	TP.CV-034	TP.CV-035	TP.CV-039
Power supply	400V - 50Hz 3~	400V - 50Hz 3~	400V - 50Hz 3~	400V - 50Hz 3~
Power	3 kW	4.3 kW	5.5 kW	11 kW
Continuous Depression	2700mmH2O	3200mmH2O	4400 mmH2O	4400 mmH2O
Max air flow rate	318 m³/h	420 m³/h	320 m³/h	600 m³/h
IN/OUT	60 mm	60 mm	70 mm	80 mm
Size	64.2x65.8x139h cm	64.2x65.8x139h cm	64.2x65.8x139h cm	64.2x65.8x139h cm
Secondary filter	•	•	•	•
Relief valve	•	•	•	•

SUPPORTING ACCESSORIES FOR THE PHARMACEUTICAL PRODUCTION LINE

MODULAR BIG BAG EMPTYING AND EASILY CONFIGURABLE STATION

THE BAG IS INSERTED INTO THE FRAME AND EMPTIED IN THE ABSENCE OF DUST.

- LOADING HOPPER SUITABLE FOR AND TO CONTAIN BIG BAGS FROM 1 TO 2 M³
- EQUIPPED WITH A HATCH FOR OPENING OF THE BIG BAG VALVE
- 0.10 KW ELECTRIC VIBRATOR
- VERSIONS IN PAINTED STEEL OR AISI 304/316 STAINLESS STEEL
- PETAL MASSAGER KIT TO FACILITATE UNLOADING OF THE BIG BAG



BAG EMPTYING STATION DESIGNED TO ENSURE MAXIMUM COMFORT AND EFFICIENCY FOR THE OPERATOR

DELFIN BAG EMPTYING STATIONS PROVIDE A DUST-FREE AREA FOR THE DISCHARGE OF DUSTY AND GRANULAR PRODUCTS.

- CONTROL PANEL FOR SETTING OF THE CLEANING TIMES OF THE FILTERING SLEEVES, PERFORMED AGAINST COMPRESSED AIR FLOW.
- OPTIONAL ELECTRICAL/PLC INTERFACE FOR THE PHARMACEUTICAL UNIT
- WITH LOADING HOOD AND SLIDING DOOR.
- FAN STARTING SENSOR.
- VERSION IN AISI 304 STAINLESS STEEL AND CERTIFIED FOR USE IN ATEX 22 ZONE
- EASY TO CLEAN AND TO PERFORM MAINTENANCE ON

DOSING STATIONS WITH BINS SUITABLE FOR THE CONTAINMENT OR CONVEYING OF POWDERS AND MIXTURES SAFELY WITHIN THE PRODUCTION DEPARTMENTS

THE DELFIN STORAGE SILO IS IDEAL FOR STORING AND HOLDING MATERIAL IN AN EASY, SAFE AND LEAK-FREE MANNER.

- WIDE RANGE OF STORAGE BIN OR SILOS, FROM 30 TO 1000 LITRES, MADE OF STAINLESS STEEL.
- EASILY TRANSPORTABLE, THANKS TO THE TROLLEY STRUCTURE AND ITS SUITABILITY FOR FORKLIFT FORK INSERTION.
- PERFECT PRESERVATION OF THE PRODUCT AND UNALTERABILITY OVER TIME OF PHYSICAL AND ORGANOLEPTIC CHARACTERISTICS.
- EASY TO CLEAN AND TO PERFORM MAINTENANCE ON



Delfin is a global leader in the production of industrial suction and pneumatic conveying solutions for every industry. Our mission is to create value through innovative solutions that improve the efficiency, safety and productivity of our customers.

The Delfin Pneumatic Conveyors division offers effective solutions to transfer powders, granules or solids, helping professionals and industries around the world to increase their productivity. Thanks to our mix of know-how and experience in the sector, we offer advice, study and implementation of a customised pneumatic conveying system on your production line.



Delfin Srl • Strada della Merla 49/A • 10036 Settimo T.se (To) Italy
Tel. +39 011 800 55 00
delfin@delfinconveyors.com • delfinconveyors.com